

<b>A</b>	F310E	1X
	Part no	No of items

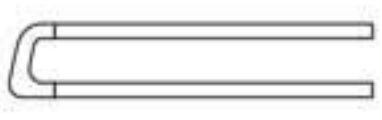

<b>B</b>	F521	4X
	Part no	No of items

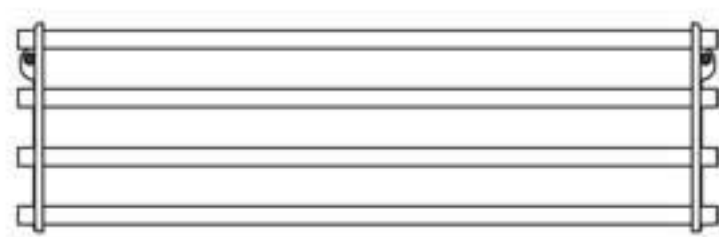

<b>C</b>	FS444	1X
	Part no	No of items



<b>D</b>	F310A	2X
	Part no	No of items

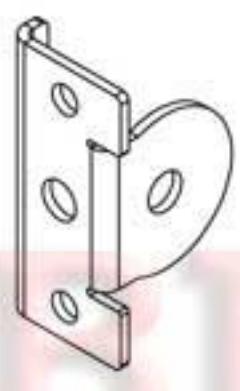

<b>E</b>	F310B	2X
	Part no	No of items





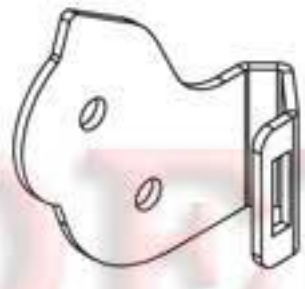



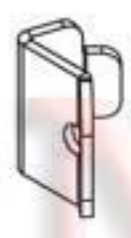



<b>F</b>	F310CL	1X
	Part no	No of items



<b>G</b>	F310CR	1X
	Part no	No of items



<b>H</b>	F310D	2X
	Part no	No of items

<p>M-R3015M8S 2X</p> 	<p>M-460641BF 2X</p>  rubber	<p>M-460641D 12X</p>  rubber	<p>M-460641AY 8X</p>  rubber end caps	<p>M-460641AL 8X</p>  plastic end caps
<p>M-R3015M835S 2X</p> 	<p>M-SR4025M820S 2X</p> 	<p>M-R3015M610S 2X</p> 	<p>M-VBM8x30S 2X</p> 	<p>M-VBM8x25S 2X</p> 

STEP 1



M-460641AY  
8X

rubber end caps

STEP 2



M-460641AL  
8X

plastic end caps

STEP 3

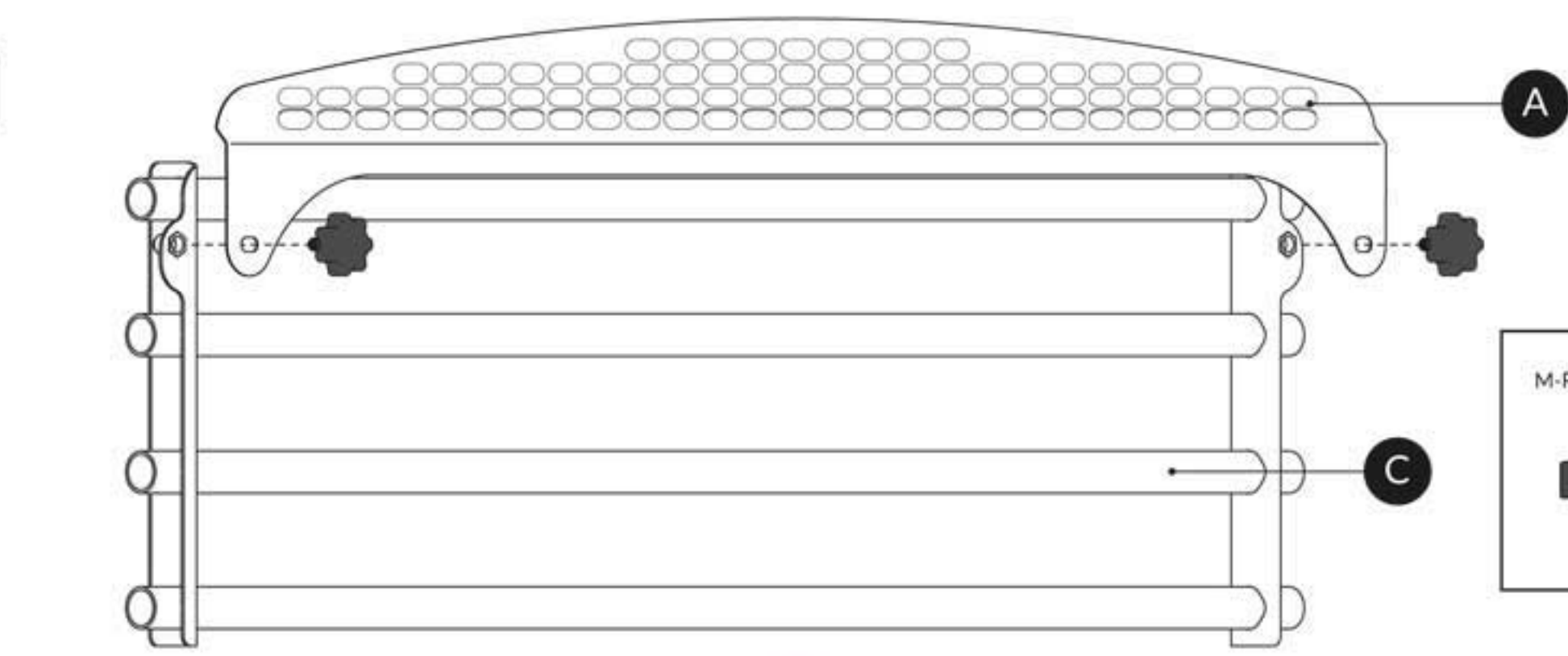

M-R3015M610S  
2X

STEP 4

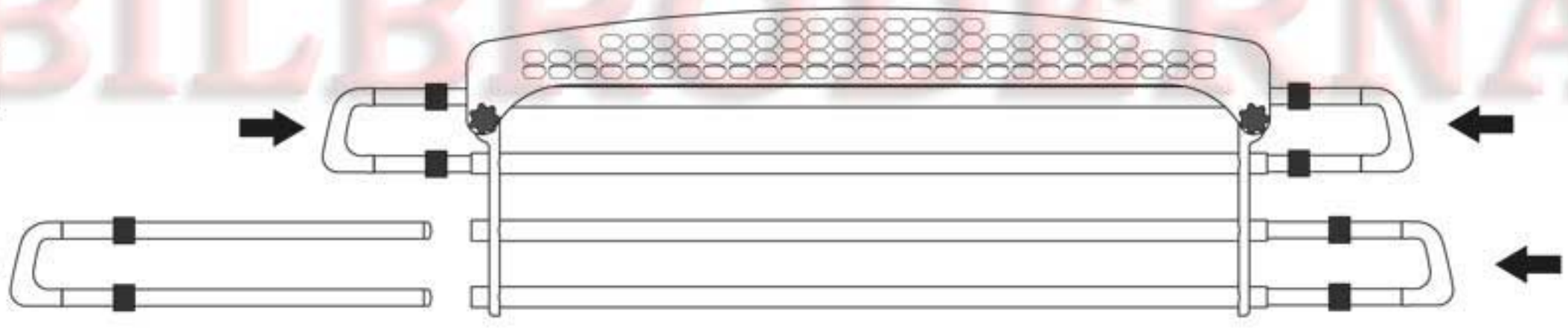

STEP 5

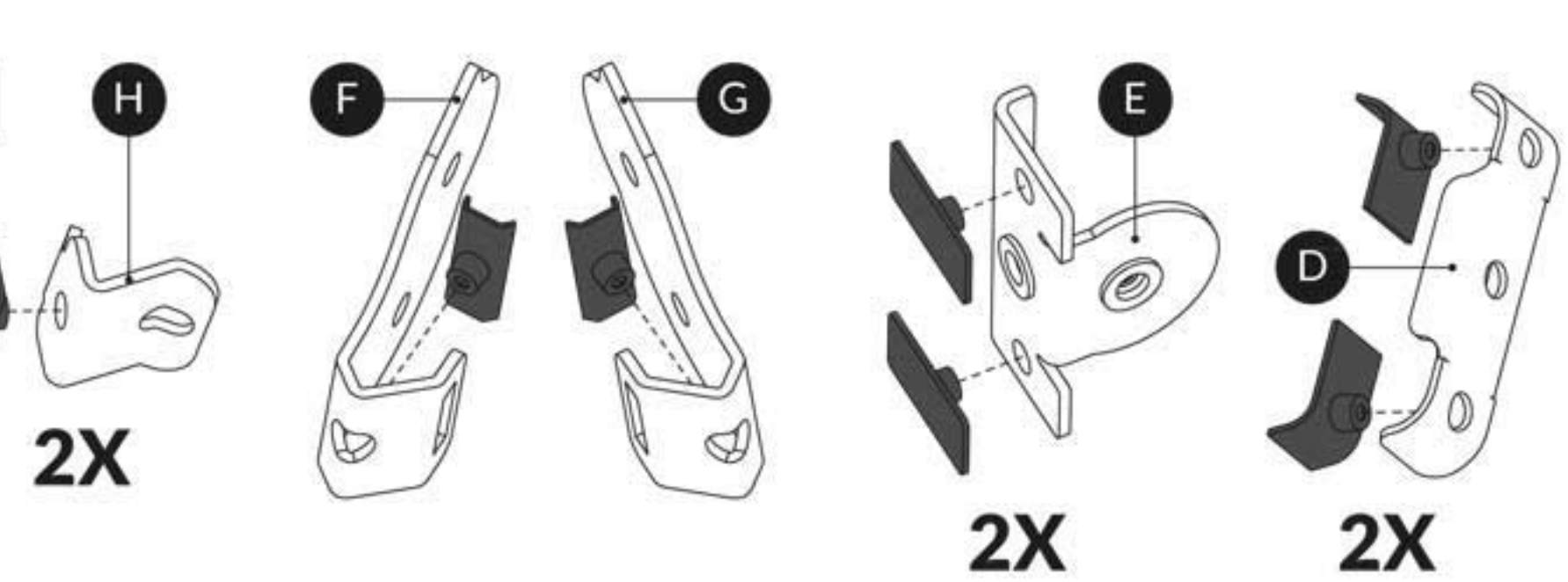

M-460641D  
12X

rubber



STEP 6

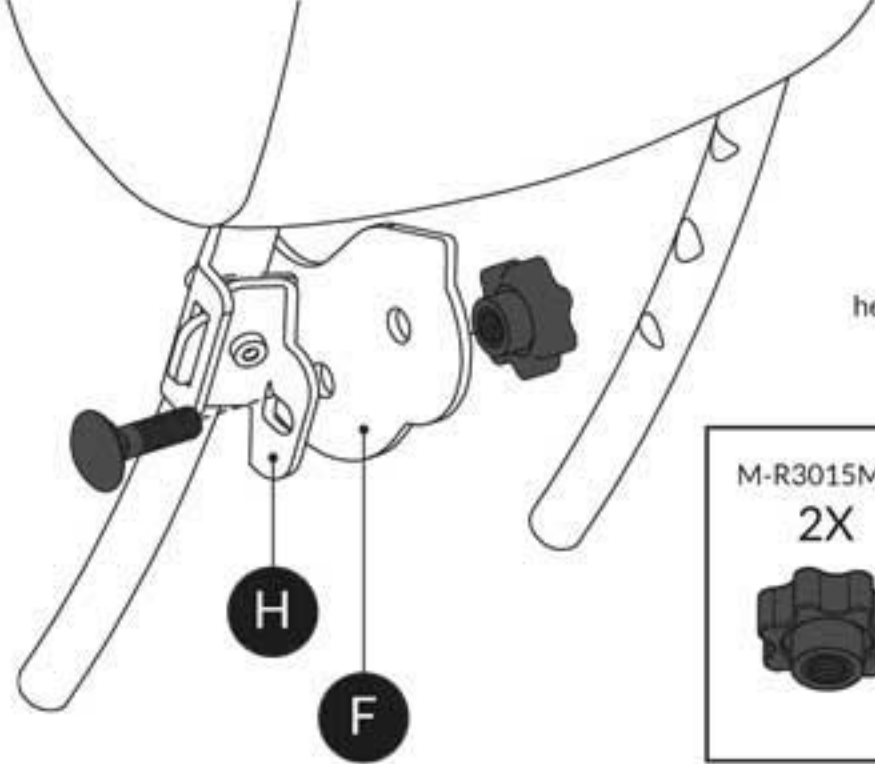

Depending on the size of the headrest's pipe use M-VBM8x25S or M-VBM8x30S

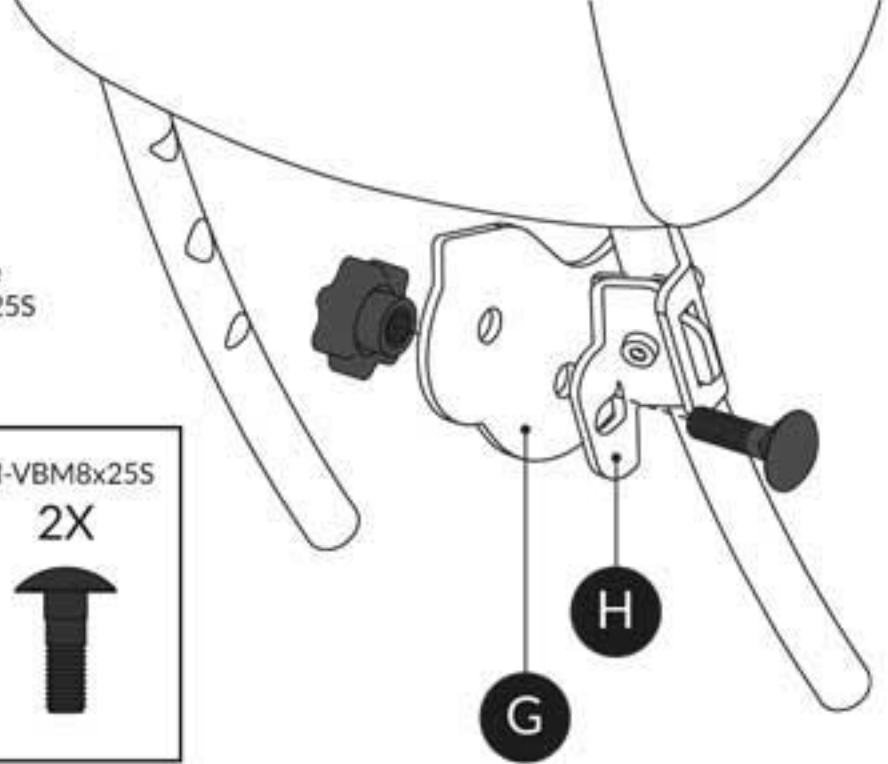
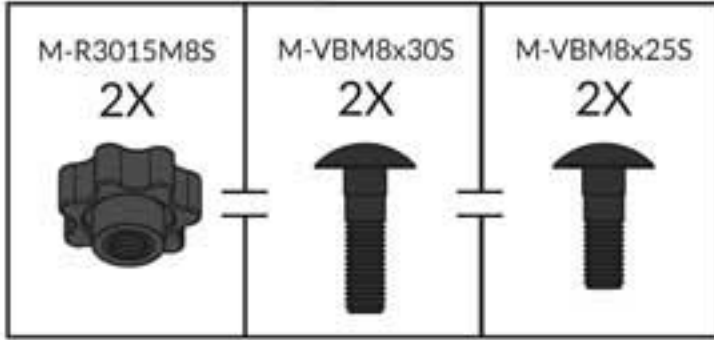

STEP 7

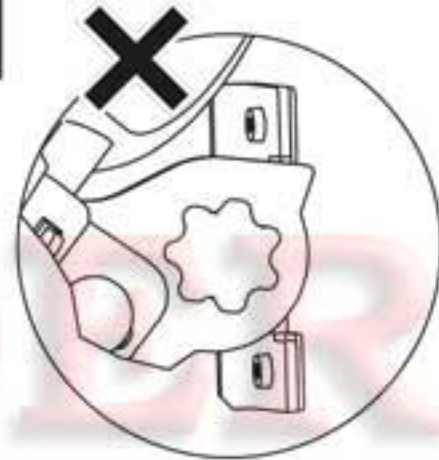
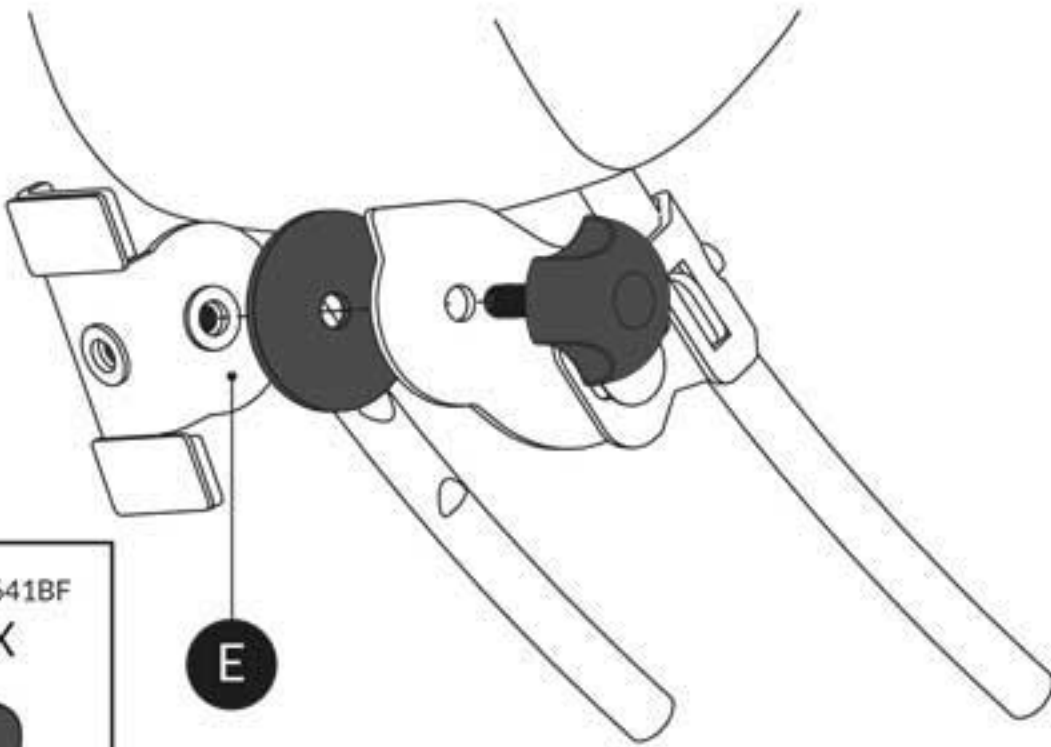
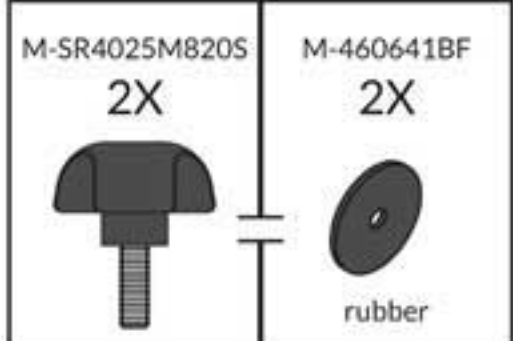
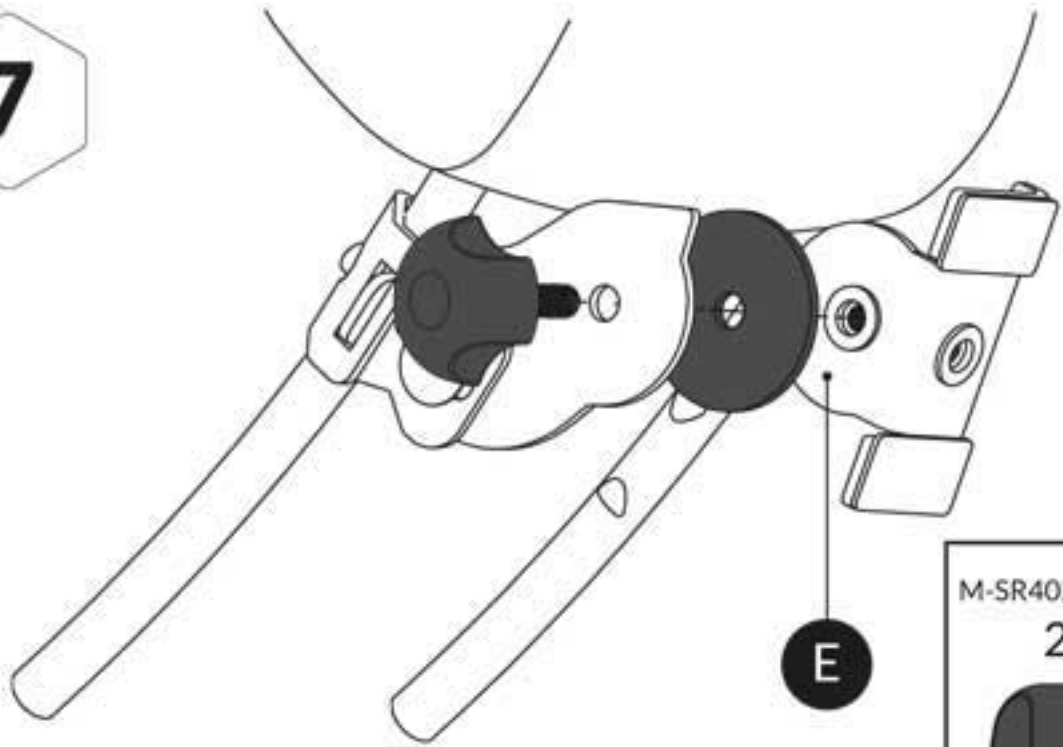

STEP 8

